



## LOW POWER GENERATING SET

**RAC3101**

**USER GUIDE**

CAUTION: Read this manual before using this machine!

# CONTENTS

1. SAFETY INSTRUCTIONS.....	3
2. PARTS IDENTIFICATION.....	8
3. INSTALLATION.....	8
4. CONTROLS.....	9
5. GENERATOR USE.....	11
6. PRE-OPERATION CHECK.....	14
7. STARTING/STOPPING THE ENGINE.....	16
8. MAINTENANCE.....	16
9. TRANSPORTING/STORAGE.....	20
10. TROUBLESHOOTING.....	22
11. CIRCUIT DIAGRAM.....	23
12. SPECIFICATIONS.....	24
13. DECLARATION OF CONFORMITY.....	25
14. WARRANTY.....	26
15. PRODUCT FAILURE.....	27
16. WARRANTY EXCLUSIONS.....	28

# 1. SAFETY INSTRUCTIONS

## Warning:

1. Attention! Exhaust gases are toxic. Do not operate the generator in a room without ventilation system!
2. Children should be protected by keeping them at a safe distance from the generator set!
3. Refilling of the generating sets are not allowed during the operation!
4. If the generator will be mounted in a closed room, relevant safety regulations against fire and explosion should be followed!
5. Do not connect to household circuit!
6. Do not use in wet condition!
7. Keep in flammable away!
8. When refuelling:
  - a) Stop engine;
  - b) No smoking;
  - c) Do not spill.

## General security instructions

- The operator must know the principles of functioning and the structure of the generator and the motor. He must know how to stop the motor in case of urgency and how to manipulate the controls.
- Never let children use this device.
- Never let people who do not know these instructions use this device. Local regulations may impose restrictions on the age of the user.
- Please do not use this device when people, especially children, or pets are nearby. Direct them away from the working area.
- The operator or the user are responsible for possible accidents or damage to other persons or to their property.
- Do not wear loose clothing or jewellery as this can get caught in the machinery as it runs.
- Use safety equipment. Wear protective gear such as an anti-dust mask, non-slip safety shoes, a helmet or hearing protection.
- Stay vigilant, watch what you are doing and show good sense when you use the generator. Do not use if you are tired or under the influence of drugs, alcohol or medicines.
- Install the generator in a place that is well ventilated and make sure that there is at least 1.5 metres between the generator and the walls of the building or other equipment. Do not place flammable liquids or gases near the generator.
- Do not run the generator in an enclosed or badly-ventilated space. The exhaust gas from the motor contains carbon monoxide which is toxic and may lead to a loss of consciousness or death.
- Run the generator in respect of the power indicated in the user's manual. Do not run the generator with an overload or at excessive speed.
- The silencer of the generator becomes extremely hot when the motor runs or even for a time after it has stopped. Do not touch it as it will burn you.
- Do not transport or move the generator until it has cooled down.
- Perform periodic maintenance and resolve problems that appear immediately. Do not run the generator before correcting any fault detected.
- The generator uses a system of air-cooling, and it is necessary to clean its components regularly, including the grilles, the cover of the fan and the fan itself so as to ensure cooling.
- Keep the fuel filter clean, and change the oil of the motor regularly.
- Periodically check the installation of the connections and the tightness of the fixations, re-

tightening them if necessary.

- Clean the components of the air filter periodically, and replace the air filter when necessary.
- Remove any electrical equipment that is plugged in before starting or stopping the generator.
- Before transporting the generator, you must empty the fuel tank.
- Maintenance and repair of the generator must be carried out by a qualified technician from an authorized after-sales service center.
- The generator must not be altered or modified. Any intervention must be done by an authorized after-sales service center.
- Installation and major repair work shall be carried out only by specifically trained personnel

 **Warning:** when you start the generator with the cord, watch out for sudden changes in the rotation of the motor!!! Risk of wounding!!! Never cover the generator when it is running. The cut-out mounted on the generator has the aim of reducing the risk of electric shock. If it needs to be replaced with another cut-out, the latter must correspond to the technical specifications of the generator. Due to important mechanical constraints, it is necessary to use a flexible sheathed cable with a strong rubber protective layer (conforming to IEC 245-4) or a similar cable. If using an electrical extension cable, the total length of the extension must not exceed 60m when the section of the wire is 1.5mm<sup>2</sup> and must not exceed 100m when the section of the wire is 2.5mm<sup>2</sup>.

### **Additional requirements for low-power generating sets for use by laymen**

- Protect children by keeping them at a safe distance from the generating set.
- Fuel is combustible and easily ignited. Do not refuel during operation. Do not refuel while smoking or near naked flames. Do not spill fuel.
- Some parts of the internal combustion engine are hot and may cause burns. Pay attention to the warnings on the generating set.
- Engine exhaust gases are toxic. Do not operate the generating set in unventilated rooms. When installed in ventilated rooms, additional requirements for fire and explosion protection shall be observed.
- Before use, the generating set and its electrical equipment (including lines and plug connections) should be checked to ensure that they are not defective.
- Protection against electrical shock depends on circuit breakers specially matched to the generating set. If the circuit breakers require replacement, they should be replaced with a circuit breaker having identical ratings and performances characteristics.
- Due to high mechanical stresses, only tough rubber-sheathed flexible cable (in accordance with IEC 60245-4) or the equivalent should be used.
- The user shall conform to regulations of electrical safety applicable to the place where the generating sets are used.
- The user must respect the requirements and precautions in the case of resupply by generating sets of an installation, depending on existing protective measures in this installation and applicable regulations.
- Generating sets should only be loaded up to their rated power under the rated ambient conditions.
- Prior to commencing maintenance work it shall be ensured that untimely start-up is not possible.

### **Security measures when filling the fuel tank**

- The fuel is extremely flammable and poisonous.
- This generator only uses petrol (gasoline); any other kind of fuel will damage the motor.
- Do not overfill the tank with petrol to avoid spilling. If you notice a spill, it must be wiped up completely with a dry cloth before starting the motor.

- If you swallow fuel by mistake, if you inhale fuel vapours or if you get drops of fuel in your eyes, see a doctor immediately. If a certain quantity of fuel is spilt on your skin or clothing, wash or change your clothes.
- Always stop the motor of the generator when filling it with fuel.
- Never fill the fuel tank while smoking or near a naked flame.
- Make sure you don't spill fuel on the motor and the exhaust grille of the generator during filling with fuel.
- Keep the fuel in an appropriate recipient and sheltered from any sources of fire.
- Carry out filling in a safe place, and slowly open the fuel cap to release the pressure which has built up inside the tank. Wipe up any drops of petrol that have spilled before starting the motor.
- To prevent fire, move the generator at least 4 metres away from the area for filling with fuel.
- Make sure that the fuel cap is tightly closed before starting.
- Do not keep petrol in the tank for a long time.
- While using or transporting the generator, make sure you keep the generator upright, otherwise the fuel may escape from the carburettor or the fuel tank.

### **Electrical safety**

Before each use ensure that the load to be connected does not exceed the power of the current produced by the generator.

**To avoid electric shock, you must follow the following instructions:**

- Do not touch the generator with wet hands.
- Do not run the generator under rain or snow.
- Do not run the generator near water.
- Connect the generator to earth. Use a sufficiently thick conductor for the earth wire.
- Do not operate the generator in parallel with another generator.
- If using electrical extensions, make sure that they are sufficiently thick to transport the current and that they are used correctly.



The connection of a generator used for auxiliary power to the electrical installation of a building must be performed by a qualified electrician, and in conformity to the provisions of the applicable laws and norms in the field of electricity. Incorrect connections will cause leakage of the current from the generator into the lines of the public electricity company. Such leakage could electrocute the workers of the public electricity company working on the network or other persons in contact with the line during a power cut. Also, when the public power supply is re-established, the generator can explode, catch fire or generate fires in the building's electrical installation.

















Before connecting electrical devices to the generator, make sure that their voltage specifications and frequency of functioning correspond to the technical characteristics of the generator. There may be damage if the device connected is not designed to function with a voltage tolerance of +/- 10% or a frequency tolerance of +/- 3 % compared with those of the generator.

### **Protection of the environment**

- You must periodically check the silencer (Before doing this, switch off the generator and let it cool completely). A damaged silencer increases noise.
- Do not throw motor oil into the drains but deposit it at a collection point set up for that purpose.
- The fuel for this machine is combustible and explosive. After stopping the machine, you must handle the remaining fuel correctly and meet local environmental requirements.
- To dispose residual fluids, proceed as follows:

- Close the fuel tap
- Drain fuel from the fuel tank
- Empty carburetor fuel

## **Symbol explanation**

	Attention!
	Please read the manual carefully before using the unit!
	Conforms to relevant safety standards.
	Do not dispose of old appliances with domestic rubbish.
	Add engine oil.
	Guaranteed sound power level.
	No naked flames.
	Ground connection.
	It is forbidden to run the generator in an enclosed room because exhaust emissions can lead humans or animals to coma to death.
	Do not connect with the electricity system.
	Keep away from the machine.
	Danger of electric shock.
	Carbon monoxide (CO) danger.
	Fire hazard.
	Risk of being burnt.



## Warnings on the product

Read them carefully before using the generator.

 **AVERTISSEMENTS / ADVERTENCIA**

 Assurez-vous qu'il n'y a pas d'écoulement de carburant ou de fuite!  
Asegúrese de la ausencia de derrames o fugas de combustible!

 **AVERTISSEMENT/ADVERTENCIA**

Les gaz d'échappement contiennent du monoxyde de carbone, ce qui est extrêmement toxique. Ne jamais utiliser dans une zone fermée sans ventilation adéquate.  
Los gases emitidos contienen monóxido de carbono, que es tóxico. No utilizar nunca en un lugar cerrado y desprovisto de una buena ventilación.

**MAINTENANCE FILTRE A AIR  
MANTENIMIENTO DEL FILTRO DE AIRE**

Nettoyez le filtre une fois toutes les 50 heures de fonctionnement, une fois toutes les 10 heures de fonctionnement dans un endroit poussiéreux. Procédure de nettoyage du filtre: nettoyer dans un solvant, essorer, tremper dans une huile de moteur propre, essorer l'excès d'huile.  
Limpie el elemento filtrante cada 50 horas de uso. Una vez cada 10 horas de uso en lugares polvorientos. Procedimiento de limpieza del elemento filtrante: limpie con un disolvente que tenga un punto de inflamación alto, presar, sumergir en aceite de motor limpio, presar para retirar el exceso de aceite.

 **AVERTISSEMENT/ADVERTENCIA**

Arrêtez le moteur avant de faire le plein.  
Pare el motor antes de repostar.

 **REMARQUE/NOTA**

Echappement à température élevée!  
Escape a temperatura elevada!



Pièce très chaude. Ne pas toucher!  
Pieza muy caliente. No tocar!



## 2. PARTS IDENTIFICATION

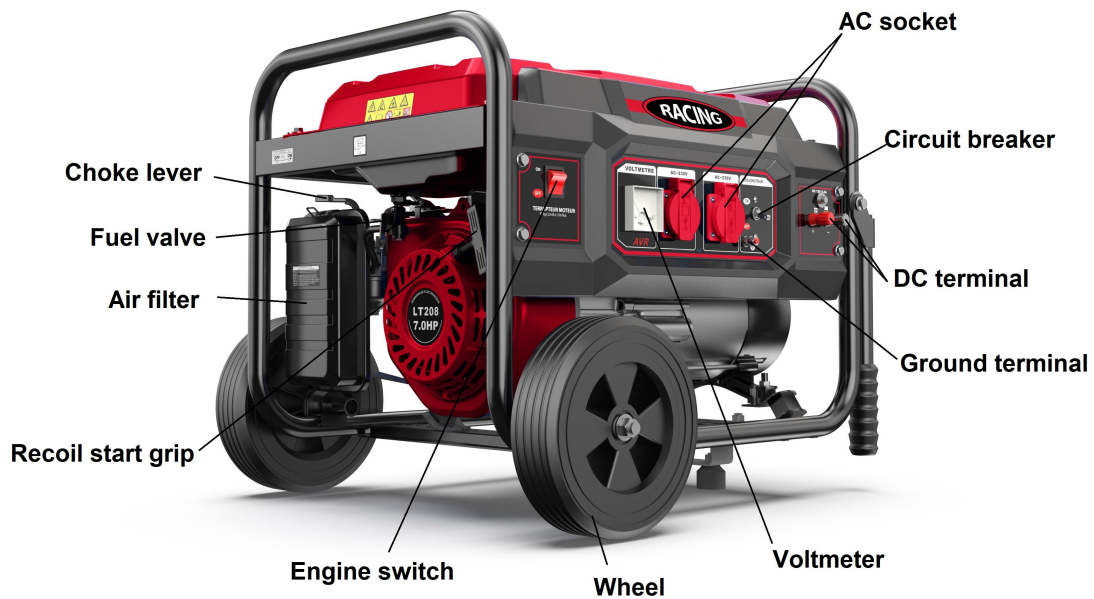

**NOTE:** Diagrams may vary according to the types.

## 3. INSTALLATION

### 1) Wheels

- Install the shaft on the machine.
- Install the wheel, flat washer, spring washer, and nut on the shaft in that order.
- Repetitive operation for the other side.

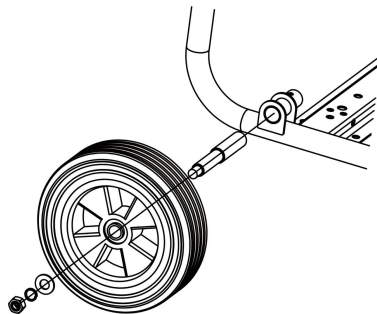

### 2) Feet

- Install the two rack feet onto the support feet with two nuts.
- Install the entire frame onto the rack with two nuts and two bolts.

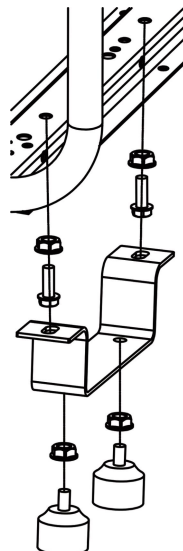



### 3) Handles

- Put the tool in the normal position.
- On each side, locate two holes. This is the place to install the handles.
- Install the handles, then secure them with the screw and nut provided.

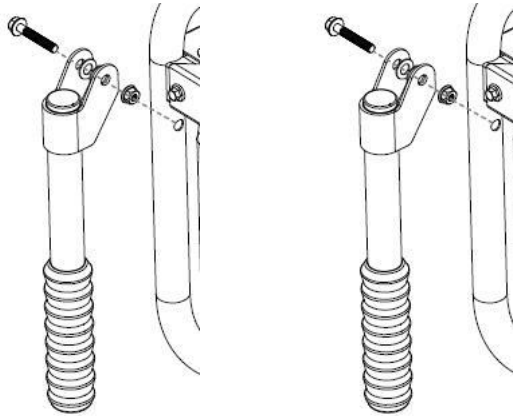

## 4. CONTROLS

### 1) Engine Switch

To start and stop the engine.

Switch position:

OFF: To Stop the engine. Key can be removed/inserted.

ON: To run the engine after starting.

START: To start the engine by turning the starter motor.

With in Electric Starter

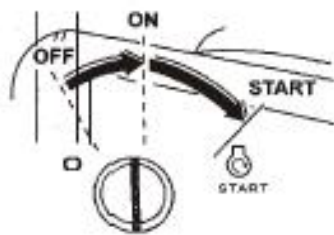

Without Electric Starter

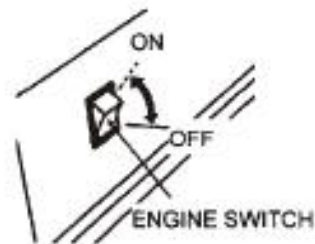

Return the key to the ON position once the engine has started. Do not use the starter for more than 5 seconds at a time. If the engine fails to start, release the switch and wait 10 seconds before operating the starter again.

### 2) Recoil Starter

To start the engine, pull the starter grip lightly until resistance is felt, then pull briskly.

#### NOTICE

**Do not allow the starter to snap back against the engine. Return it gently to prevent damage to the starter.**



### 3) Fuel Valve

The fuel valve is located between the fuel tank and carburetor. When the valve lever is in the ON position, fuel is allowed to flow from the fuel tank to the carburetor. Be sure to return the lever to OFF after stopping the engine.

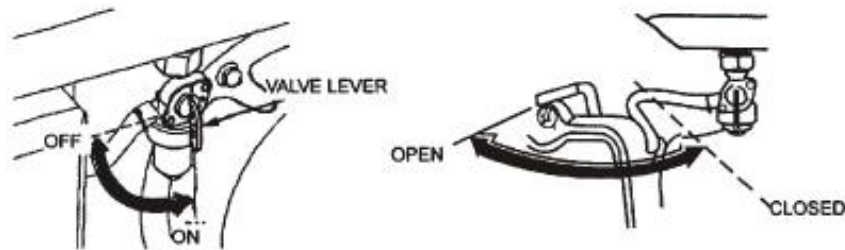

### 4) Choke

The choke is used to provide an enriched fuel mixture when starting a cold engine. It can be opened and closed by operating the choke lever or choke rod manually. Move the lever or the rod to the CLOSE position to enrich the mixture.

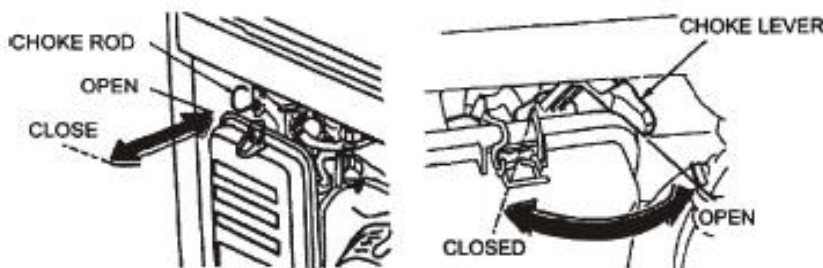

### 5) Circuit Breaker

The circuit breaker will automatically switch OFF if there is a short circuit or a significant overload of the generator at the receptacle. If the circuit breaker is switched OFF automatically, check that the appliance is working properly and does not exceed the rated load capacity of the circuit before switching the circuit breaker ON again. The circuit breaker may be used to switch the generator power ON or OFF.

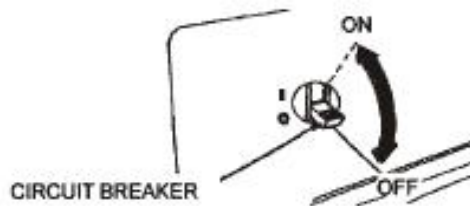

### 6) Ground Terminal

The generator ground terminal is connected to the panel of the generator, the metal non-current carrying parts of the generator, and the ground terminals of each receptacle. Before using the ground terminal, consult a qualified electrician, electrical inspector or local agency having jurisdiction for local codes or ordinances that apply to the intended use of the generator.

### 7) Oil Alert System

The oil alert system is designed to prevent engine damage caused by an insufficient amount of oil in the crankcase. Before the oil level in the crankcase can fall below a safe limit, the oil alert system will automatically shut down the engine (the engine switch will remain in the ON position). The oil alert system shuts down the engine and the engine will not start. If this occurs, first-check engine oil.

## 5. GENERATOR USE

### 1) Connections to a Building's Electrical System

Connections for standby power to a building's electrical system must be made by a qualified electrician. The connection must isolate the generator power from utility power, and must comply with all applicable laws and electrical codes.

#### **WARNING**

Improper connections to a building's electrical system, can allow electrical current from the generator to feedback into the utility lines. Such feedback may electrocute utility company workers or others who contact the lines during a power outage. Consult the utility company or a qualified electrician.

#### **CAUTION**

Improper connections to a building's electrical system can allow electrical current from the utility company to feedback into the generator. When utility power is restored, the generator may explode, burn, or cause fires in the building's electrical system.

### 2) Ground System

To prevent electrical shock from faulty appliances, the generator should be grounded. Connect a length of heavy wire between the ground terminal and the ground source. The generators have a system ground that connects generator frame components to the ground terminals in the AC output receptacles. The system ground is not connected to the AC neutral wire.

If the generator is tested by a receptacle tester, it will not show the same ground circuit condition as for a home receptacle.

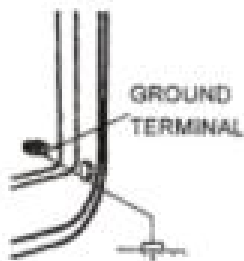

### Special Requirements

There may be Federal or State Occupational Safety and Health Administration (OSHA) regulations, local codes, or ordinances that apply to the intended use of the generator. Please consult a qualified electrician, electrical inspector, or the local agency having jurisdiction.

- In some areas, generators are required to be registered with local utility companies.
- If the generator is used at a construction site, there may be additional regulations which must be observed.

### 3) AC Applications

Before connecting an appliance or power cord to the generator:

- Make sure that it is in good working order. Faulty appliances or power cords can create a potential for electrical shock.
- If an appliance begins to operate abnormally, becomes sluggish or stops suddenly, turn it off immediately. Disconnect the appliance, and determine whether the problem is the appliance, or if the rated load capacity of the generator has been exceeded.
- Make sure that the electrical, rating of the tool or appliance does not exceed that of the generator. Never exceed the maximum power rating of the generator. Power levels between rated and maximum may be used for no more than 30 minutes.

## NOTICE

**Substantial overloading will switch off the circuit breaker.**

**Exceeding the time limit for maximum power operation or slightly overloading the generator may not switch the circuit breaker OFF, but will shorten the service life of the generator.**

Limit operation requiring maximum power to 30 minutes.

For continuous operation, do not exceed the rated power.

In any case, the total power requirements (VA) of all appliances connected must be considered. Appliance and power tool manufacturers usually list rating information near the model number or serial number.

### 4) AC Operation

- ① Start the engine
- ② Switch the AC circuit breaker ON.
- ③ Plug in the appliance.

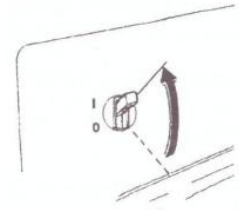

Most motorized appliances require more than their rated wattage for startup.

Do not exceed the current limit specified for any one receptacle. If an overloaded circuit causes the AC circuit breaker to switch OFF, reduce the electrical load on the circuit, wait a few minutes and then reset the circuit breaker.

### 5) DC OPERATION ( If available)

#### DC Terminals

The DC terminals may ONLY be used for charging 12 volt automotive type batteries. The terminals are colored red to identify the positive (+) terminal and black to identify the negative (-) terminal. The battery must be connected to the generator DC terminals with the proper polarity (battery positive to generator red terminal and battery negative to the generator black terminal).

With DC Circuit Protector

With DC Fuse

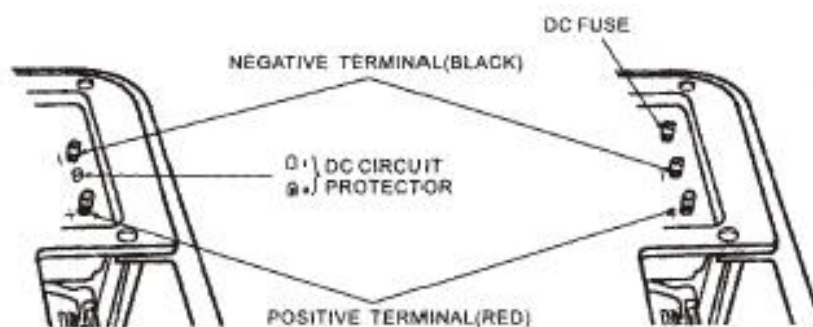

#### DC Circuit Protector (or DC Fuse)

The DC circuit protector (or DC Fuse) automatically shuts off the DC battery charging circuit when the DC circuit is overloaded, when there is a problem with the battery, or the connections between the battery and the generator are improper.

The indicator inside the DC circuit protector button will pop out to show that the DC circuit protector has switched off. Wait a few minutes and push the button in to reset the DC circuit protector.

#### Connecting the battery cables:

- 1) Before connecting charging cables to a battery that is installed in a vehicle, disconnect the vehicle's grounded battery cable.

## **⚠ WARNING**

The battery gives off explosive gases; keep spark, flames and cigarettes away. Provide adequate ventilation when charging or using batteries.

- a) Use specifically designated battery. Use of any other battery may create a risk of injury and fire.
  - b) Keep battery no damage, No make a connection from one terminal to another. Shorting the battery terminals together may cause burns or a fire.
  - c) Under abusive conditions, liquid may be ejected from the battery; avoid contact. If contact accidentally occurs, flush with water. If liquid contacts eyes, additionally seek medical help. Liquid ejected from the battery may cause irritation or burns.
- 2) Connect the positive (+) battery cable to the battery positive (+) terminal.
  - 3) Connect the other end of the positive (+) battery cable to the generator.
  - 4) Connect the negative (-) battery cable to the battery negative (-) terminal.
  - 5) Connect the other end of the negative (-) battery cable to the generator.
  - 6) Start the generator.

## **NOTICE**

**Do not start the vehicle while the battery charging cables are connected and the generator is running. The vehicle or the generator may be damaged.**

An overloaded DC circuit will fuse the DC fuse, if this happens, replace fuse.

An overloaded DC circuit, excessive current draw by the battery, or a wiring problem will trip the DC circuit protector (PUSH button extends out). If this happens, wait a few minutes before pushing in the circuit protector to resume operation. If the circuit protector continues to go OFF, discontinue charging and see your authorized generator dealer.

### **Disconnecting the battery cables:**

- 1) Stop the engine.
- 2) Disconnect the negative (-) battery cable from the generator negative (-) terminal.
- 3) Disconnect the other end of the negative (-) battery cable from the battery negative (-) terminal.
- 4) Disconnect the positive (+) battery cable from the generator positive (+) terminal.
- 5) Disconnect the other end of the positive (+) battery cable to the battery positive (+) terminal.
- 6) Connect the vehicle ground cable to the battery negative (-) terminal.
- 7) Reconnect the vehicle grounded battery cable.

### **6) High Altitude Operation**

At high altitude, the standard carburetor air-fuel mixture will be excessively rich. Performance will decrease, and fuel consumption will increase.

High altitude performance can be improved by installing a smaller diameter main fuel jet in the carburetor and readjusting the pilot screw. If you always operate the engine at altitudes higher than 5000 feet (1500 meters) above sea level, have an authorized generator dealer perform this carburetor modification.

Even with suitable carburetor jetting, engine horsepower will decrease approximately 3.5% for each 1000 foot (300 meter) increase in altitude. The effect of altitude on horsepower will be greater than this if no carburetor modification is made.

## **NOTICE**

**If a engine jetted for high altitude is used at a lower altitude, the lean air fuel mixture will reduce performance and may over-heat and seriously damage the engine.**

# 6. PRE-OPERATION CHECK

## 1) Engine oil

### NOTICE

Engine oil is a major factor affecting engine performance and service life. Non-detergent and 2-stroke engine oils will damage the engine and are not recommended.

Check the oil level BEFORE EACH USE with the generator on a level surface with the engine stopped.

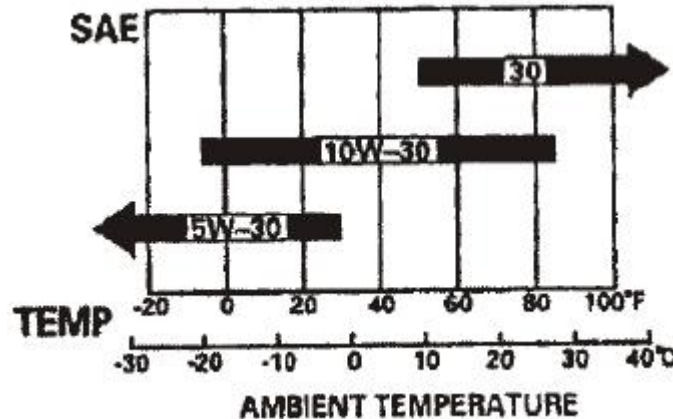

Use 4-stroke oil, or equivalent high detergent, premium quality motor oil certified to meet or exceed U.S. automobile manufacturer's requirements for Service Classification SG, SF/CC, CD. Motor oils classified SG, SF/CC, CD will show this designation on the container.

SAE 10W-30 is recommended for general temperature use. Other viscosities shown in the chart may be used when the average temperature in your area is within the indicated range.

1. Remove the oil filler cap and wipe the dipstick clean.
2. Check the oil level by inserting the dipstick into the filler neck without screwing it in.
3. If the level is low, add the recommended oil to the upper mark on the dipstick.

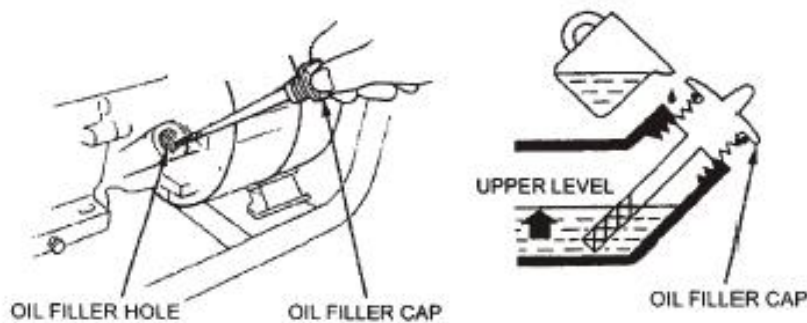

## 2) Fuel Recommendation

1. Check the fuel level gauge.
2. Refill the tank if the fuel level is low. Do not fill above the shoulder of the fuel strainer.

### WARNING

- Gasoline is extremely flammable and is explosive under certain conditions.
- Refuel in a well-ventilated area with the engine stopped. Do not smoke or allow flames or sparks in the area where the engine is refueled or where gasoline is stored.
- Do not overfill the fuel tank (there should be no fuel in the filler neck). After refueling, make sure the tank cap is closed properly and securely. Be careful not to spill fuel when refueling. Spilled fuel



or fuel vapor may ignite. If any fuel is spilled, make sure the area is dry before starting the engine.

- Avoid repeated or prolonged contact with skin or breathing of vapor.
- KEEP OUT OF REACH OF CHILDREN.

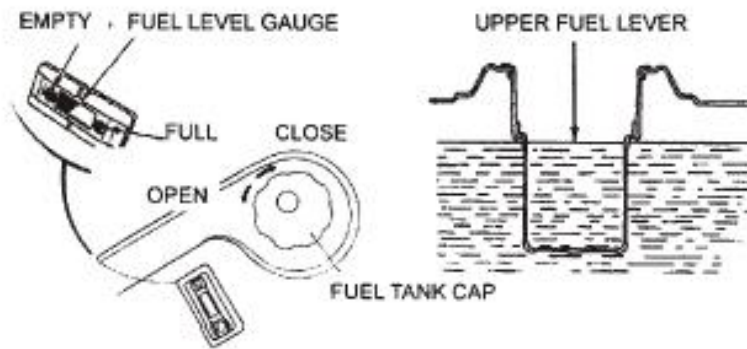

Use gasoline with a pump octane rating of 86 or higher.

We recommend unleaded gasoline because it produces fewer engine and spark plug deposits and extends exhaust system life.

Never use stale or contaminated gasoline or oil/gasoline mixture. Avoid getting dirt or water in the fuel tank.

Occasionally you may hear light “spark knock” or “pinging” (metallic rapping noise) while operating under heavy loads. This is no cause for concern.

If spark knock or pinging occurs at a steady engine speed, under normal load, change brands of gasoline. If spark knock or pinging persists, see an authorized generator dealer.

#### **NOTICE**

**Running the engine with persistent spark knock or pinging can cause engine damage.**

Running the engine with persistent spark knock or pinging is misuse, and the Distributor's Limited Warranty does not cover parts damaged by misuse.

#### **Oxygenated Fuels**

Some gasoline are blended with alcohol or an ether compound to increase the octane. These gasoline are collectively referred to as oxygenated fuels. Some areas of the United States use oxygenated fuels to help meet clean air standards. If you use an oxygenated fuel, be sure its pump octane rating is 86 or higher.

#### **Ethanol (ethyl or grain alcohol)**

Gasoline containing more than 10% ethanol by volume may cause starting or performance problems. Gasoline containing ethanol may be marketed under the name “Gasohol”.

#### **Methanol (methyl or wood alcohol)**

Gasoline containing methanol must contain cosolvents and corrosion inhibitors to protect the fuel system. Gasoline containing more than 5% methanol by volume may cause starting and/or performance problems and may damage metal, rubber and plastic parts of your fuel system.

#### **MTBE (methyl tertiary butyl ether)**

You may use gasoline containing up to 15% MTBE by volume. Before using an oxygenated fuel, try to confirm the fuel's contents. Some states (provinces in Canada) require this information to be posted on the pump. If you notice any undesirable operating symptoms, switch to a conventional unleaded gasoline. Fuel system damage or performance problems resulting from the use of an oxygenated fuel are not ours responsibility and are not covered under warranty.

## NOTICE

Oxygenated fuels can damage paint and plastic. Be careful not to spill fuel when filling your fuel tank. Damage caused by spilled fuel is not covered under warranty.

# 7. STARTING/STOPPING THE ENGINE

## Starting the engine

1. Make sure that the AC circuit breaker is in the OFF position. The generator may be hard to start if a load is connected.
2. Turn the fuel valve to the ON position.
3. Turn the choke lever or to the CLOSE position, or pull the choke rod out to the CLOSE position.
4. Start the engine

### • With recoil starter:

Turn the engine switch to the ON position.

Pull the starter grip until compression is felt, then pull briskly.

## NOTICE

Do not allow the starter grip to snap back against the engine. Return it gently to prevent damage to the starter or housing.

### • With electric starter: (Optional kit)

Turn the engine switch to the START position and hold it there for 5 seconds or until the engine starts.

## NOTICE

Operating the starter motor for more than 5 seconds can damage the motor. If the engine fails to start, release the switch and wait 10 seconds before operating the starter again. If the speed of the starter motor drops after a period of time, it indicates that the battery should be recharged.

When the engine starts, allow the engine switch to return to the ON position.

1. Turn the choke lever or push the choke rod to the OPEN position as the engine warms up.

## Stopping the engine

### In an emergency:

To stop the engine in an emergency, move the engine switch to the OFF position.

### In normal use:

1. Turn the AC circuit breaker to the OFF position. Disconnect the DC battery charging cables.
2. Turn the engine switch to the OFF position.
3. Turn the fuel valve to the OFF position.

# 8. MAINTENANCE

Good maintenance is essential for safe, economical, and trouble-free operation. It will also help reduce air pollution.

## WARNING

Exhaust gas contains poisonous carbon monoxide. Shut off the engine before performing any maintenance. If the engine must be run, make sure the area is well ventilated.

Periodic maintenance and adjustment is necessary to keep the generator in good operating condition. Perform the service and inspection at the intervals shown in the Maintenance schedule below.

### 1) MAINTENANCE SCHEDULE

REGULAR SERVICE PERIOD Performed at every indicated month or operating hour interval, whichever comes first.		Each use	First month or 20 Hrs. (3)	Every 3 months or 50 Hrs. (3)	Every 6 months or 100 Hrs. (3)	Every year or 300 Hrs. (3)
ITEM						
Engine oil	Check level	o				
	Change		o		o	
Air cleaner	Check	o				
	Clean			o(1)		
Sediment Cup	Clean				o	
Spark plug	Check-Clean				o	
Spark arrester	Clean				o	
Valve clearance	Check-Adjust					o(2)
Fuel tank and strainer	Clean					o(2)
Fuel line	Check	Every 2 years (Replace if necessary) (2)				

1) Service more frequently when used in dusty areas.

2) These items should be serviced by an authorized generator dealer, unless the owner has the proper tools and is mechanically proficient.

(3) For professional commercial use, long hours of operation to determine proper maintenance intervals.

**⚠ WARNING**

**Improper maintenance, or failure to correct a problem before operation, can cause a malfunction in which you can be seriously hurt or killed. Always follow the inspection and maintenance recommendations and schedules in this owner's manual.**

The maintenance schedule applies to normal operating conditions. If you operate your generator under severe conditions, such as sustained high-load or high-temperature operation, or use it in unusually wet or dusty conditions, consult your servicing dealer for recommendations applicable to your individual needs and use.

### 2) Tool kit

The tools supplied with the generator will help you to perform the owner maintenance procedures listed on the following page. Always keep this tool kit with the generator.

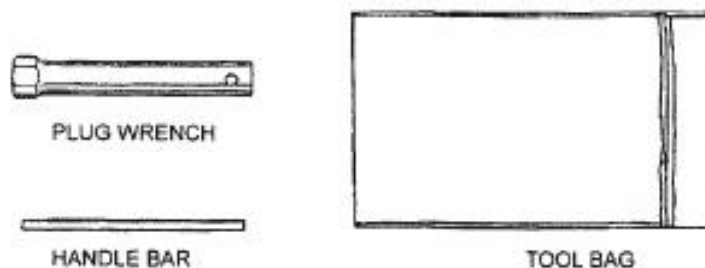

**NOTE:** Diagrams may vary according to the types.

### 3) Engine oil change

Drain the oil while the engine is warm to assure complete and rapid draining

1. Remove the drain plug and sealing washer, oil filler cap, and drain the oil
2. Reinstall the drain plug and sealing washer. Tighten the plug securely.
3. Refill with the recommended oil and check the oil level.

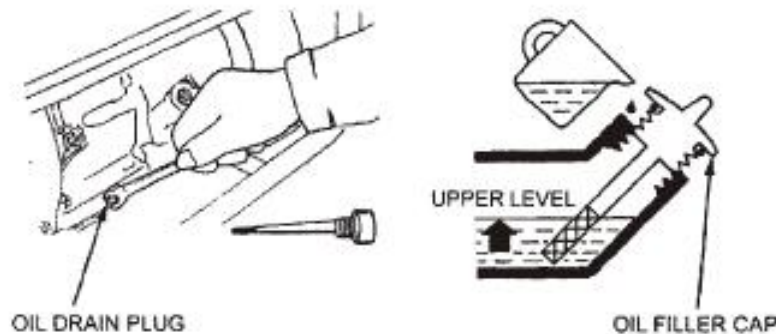

Used motor oil may cause skin cancer if repeatedly left in

#### **CAUTION**

**Used motor oil may cause cancer if repeatedly left in contact with the skin for prolonged periods. Although this is unlikely unless you handle used oil on a daily basis, it is still advisable to thoroughly wash your hands with soap and water as soon as possible after handling used oil.**

Please dispose of used motor oil in a manner that is compatible with the environment. We suggest you take it in a sealed container to your local service station or recycling center for reclamation. Do not throw it in the trash or pour it on the ground.

### 4) Air cleaner service

A dirty air cleaner will restrict air flow to the carburetor. To prevent carburetor malfunction, service the air cleaner regularly. Service more frequently when operating the generator in extremely dusty areas.

#### **WARNING**

**Using gasoline or flammable solvent to clean the filter element can cause a fire or explosion. Use only soapy water or nonflammable solvent.**

#### **NOTICE**

**Never run the generator without the air cleaner. Rapid engine wear will result.**



- 1) Unsnap the air cleaner cover clips, remove the air cleaner cover, and remove the element.
- 2) Wash the element in a solution of household detergent and warm water, then rinse thoroughly; or wash in nonflammable or high flash point solvent. Allow the element to dry thoroughly
- 3) Soak the element in clean engine oil and squeeze out the excess oil. The engine will smoke during initial start-up if too much oil is left in the element.
- 4) Reinstall the air cleaner element and the cover.

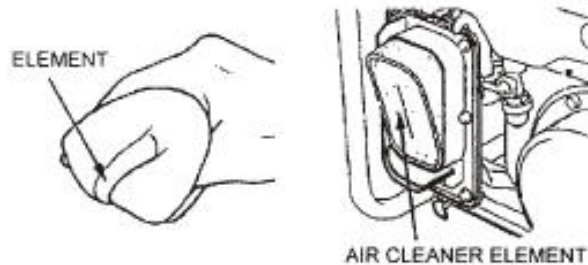

### 5) Fuel Sediment Cup Cleaning

The sediment cup prevents dirt or water which may be in the fuel tank from entering the carburetor. If the engine has not been run for a long time, the sediment cup should be cleaned.

- 1) Turn the fuel valve to the OFF position. Remove the sediment cup, and O-ring.
- 2) Clean the sediment cup, and O-ring, in nonflammable or high flash point solvent.
- 3) Reinstall O-ring, and sediment cup.
- 4) Turn the fuel valve ON and check for leaks.

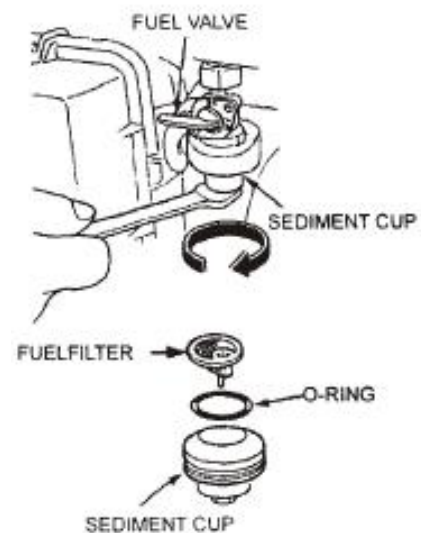

### 6) Spark Plug Service

#### Recommended spark plugs: F5T or F6TC or F7TJC or other equivalents

To ensure proper engine operation, the spark plug must be properly gapped and free of deposits. If the engine has been running, the muffler will be very hot. Be careful not to touch the muffler.

- 1) Remove the spark plug cap.
- 2) Clean any dirt from around the spark plug base.
- 3) Use the wrench supplied in the tool kit to remove the spark plug.

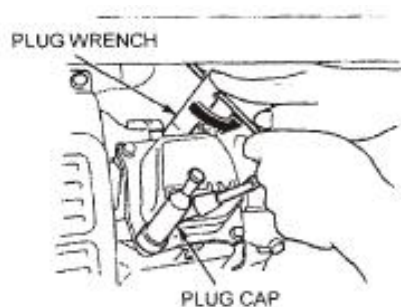

- 4) Visually inspect the spark plug. Discard it if the insulator is cracked or chipped. Clean the spark plug with a wire brush if it is to be reused.
- 5) Measure the plug gap with a feeler gauge. Correct as necessary by carefully bending the side electrode.

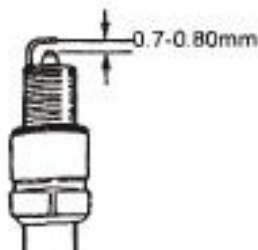

The gap should be: 0.70-0.80 mm (0.028-0.031 in).

- 6) Check that the spark plug washer is in good condition, and thread the spark plug in by hand to prevent cross-threading.
- 7) After the spark plug is seated, tighten with a spark plug wrench to compress the washer. If installing a new spark plug, tighten 1/2 turn after the spark plug seats to compress the washer. If reinstalling a used spark plug, tighten 1/8 -1/4 turn after the spark plug seats to compress the washer.

**NOTICE**

**The spark plug must be securely tightened. An improperly tightened spark plug can become very hot and could damage the engine. Never use spark plugs which have an improper heat range. Use only the recommended spark plugs or equivalent.**

## 9. TRANSPORTING/STORAGE

When transporting the generator, turn the engine switch and the fuel valve OFF. Keep the generator level to prevent fuel spillage. Fuel vapor or spilled fuel may ignite. Not turn the machine to any side, and keep the machine under horizontal position during the transporting process.

**⚠ WARNING**

**Contact with a hot engine or exhaust system can cause serious burns or fires. Let the engine cool before transporting or storing the generator.**

Take care not to drop or strike the generator when transporting. Do not place heavy objects on the generator.

Before storing the unit for an extended period:

- Be sure the storage area is free of excessive humidity and dust.
- Service according to the table below:

STORAGE TIME	RECOMMENDED SERVICE PROCEDURE TO PREVENT HARD STARTING
Less than 1 month	No preparation required.
1 to 2 months	Fill with fresh gasoline and add gasoline conditioner*
2 months to 1 year	Fill with fresh gasoline and add gasoline conditioner* Drain the carburetor float bowl. Drain the fuel sediment cup.
1 year or more	Fill with fresh gasoline and add gasoline conditioner*



	<p>Drain the carburetor float bowl.          Drain the fuel sediment cup.          Remove the spark plug. Put a tablespoon of engine oil into the cylinder.          Turn the engine slowly with the pull rope to distribute the oil.          Reinstall the spark plug.          Change the engine oil.          After removal from storage, drain the stored gasoline into a suitable container, and fill with fresh gasoline before starting.</p>
<p>*Use gasoline conditioners that are formulated to extend storage life.          Contact your authorized generator dealer for conditioner recommendations.</p>	

1) Drain the carburetor by loosening the drain screw. Drain the gasoline into a suitable container.

**⚠ WARNING**

**Gasoline is extremely flammable and is explosive under certain conditions. Perform this task in a well ventilated area with the engine stopped. Do not smoke or allow flames or sparks in the area during this procedure.**

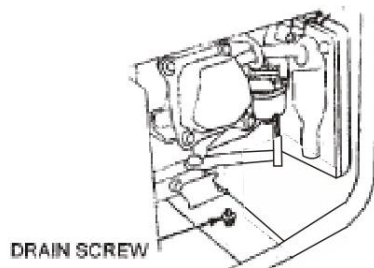

The fuel of this machine is combustible and deflagrating. After the machine has been shut down, the additional fuel must be treated properly and the local environmental requirements must be met.

2) Change the engine oil

3) Remove the spark plug, and pour about a tablespoon of clean engine oil into the cylinder. Crank the engine several revolutions to distribute the oil, then reinstall the spark plug.

4) Slowly pull the starter grip until resistance is felt. At this point, the piston is coming up on its compression stroke and both the intake and exhaust valves are closed. Storing the engine in this position will help to protect it from internal corrosion.

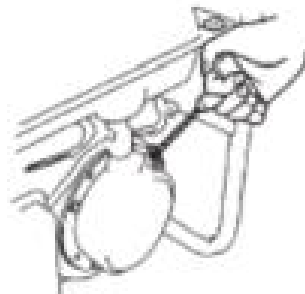

Align the notch on the starter pulley with the hole at the top of recoil starter.

The disassembled or damaged machine must be transferred to the professional organ for processing. Please make sure that the fuel and lubricant inside the machine have already been drained. Some parts of the machine are potentially dangerous for children. Place and handle all parts properly to avoid children reaching.

# 10. TROUBLESHOOTING

When the engine will not start:

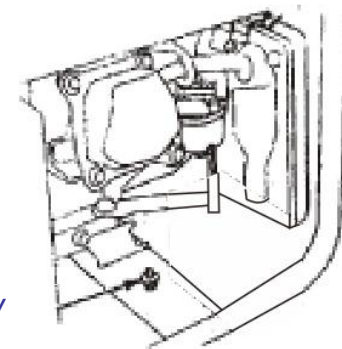
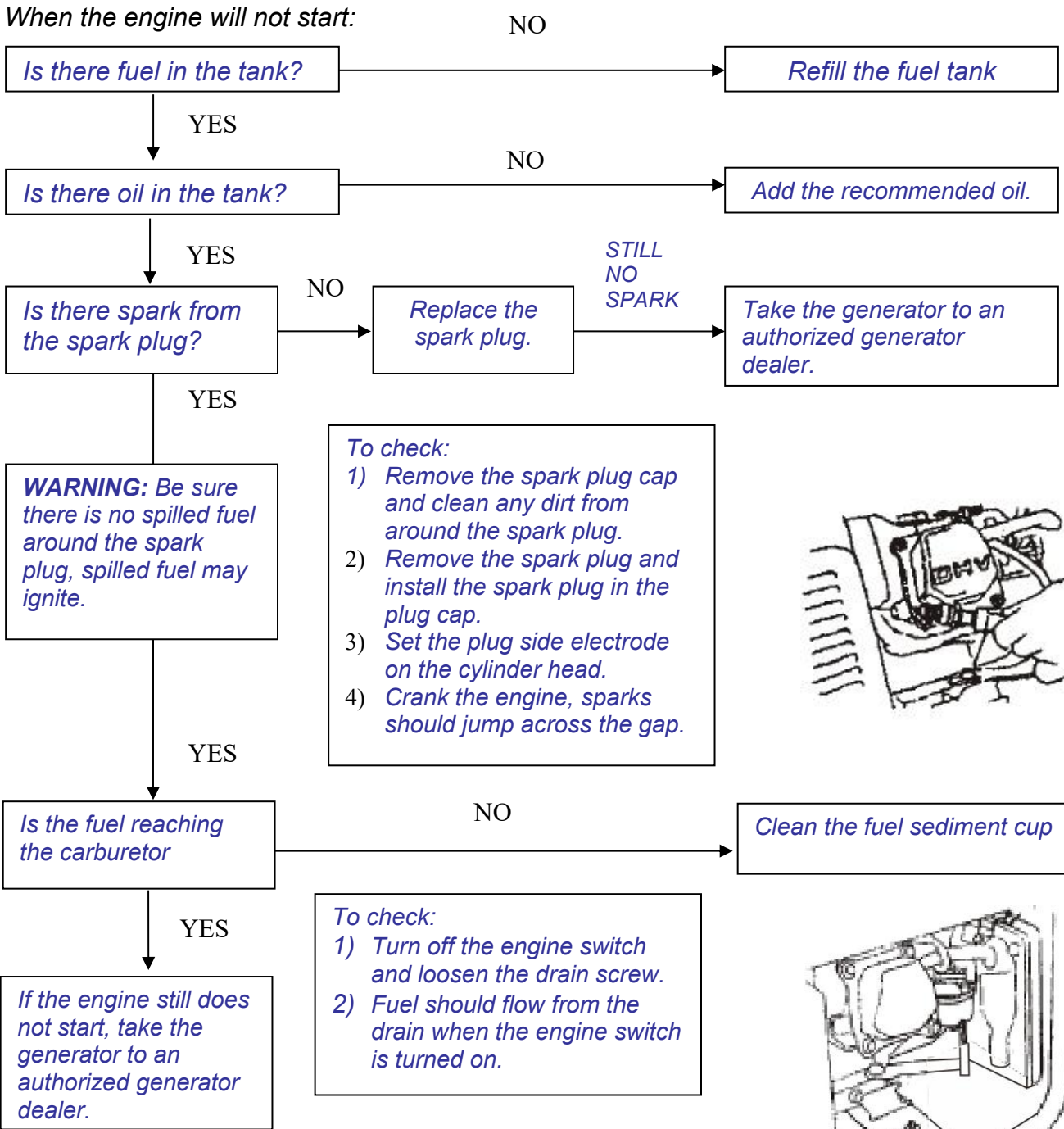

No electricity at the AC receptacles

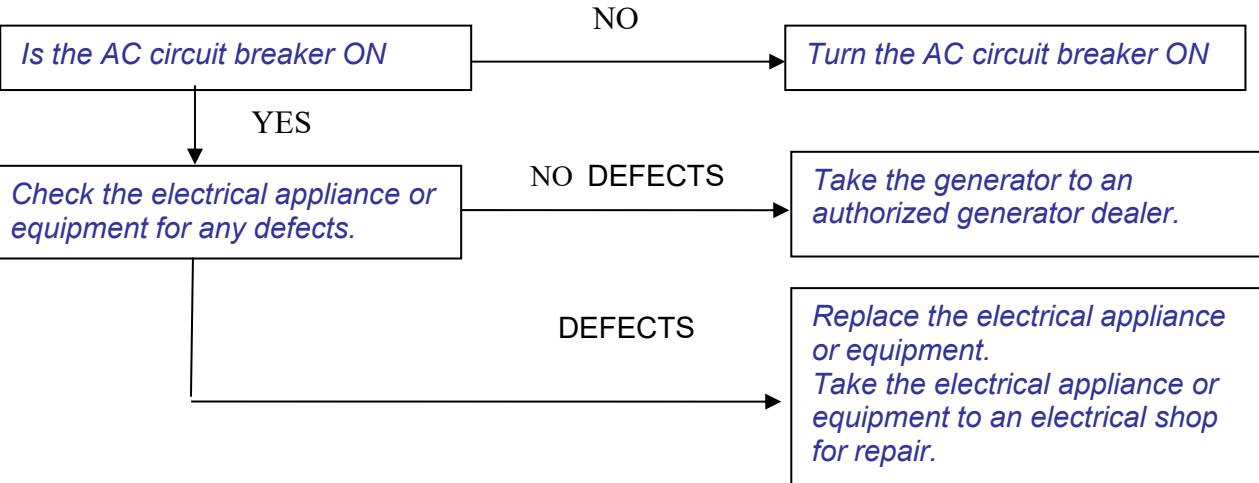

# 11. CIRCUIT DIAGRAM

Electrical Schematic Diagram

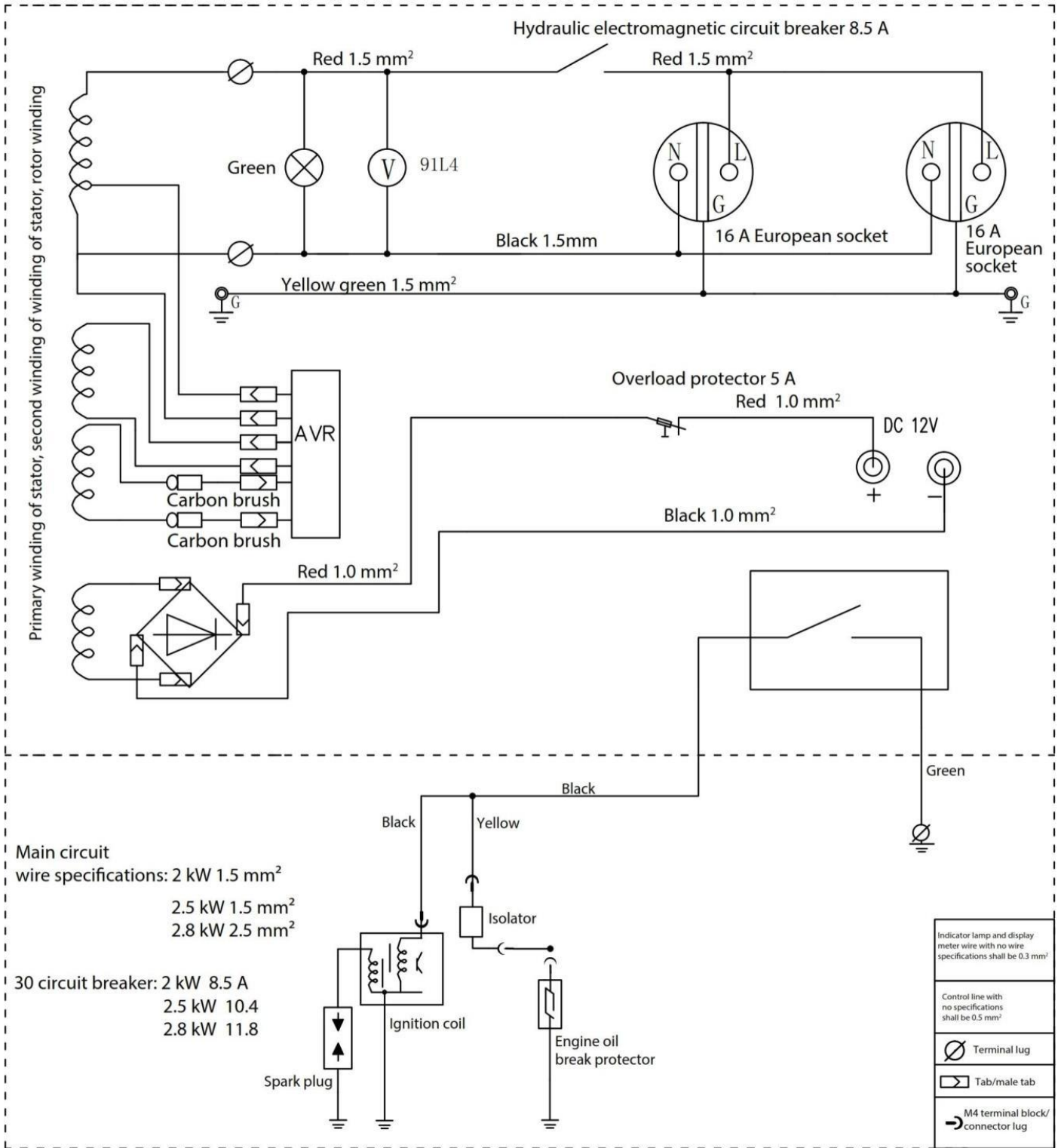

## 12. SPECIFICATIONS

Engine	Engine model	LT208
	Engine type	Single cylinder, 4-strokes, Forced air cooling, OHV.
	Displacement (CC)	208cc
	Igniting system	Transistor magneto
	Starting system	Recoil
	Lube Oil capacity (L)	0.6L
Generator SET	AC output Voltage	230 V~
	AC Frequency	50 Hz
	AC rated output power (PRP)	2.7 kW
	AC max output power	Max. 3.0 kW
	Rated speed	3000/min
	Power factor	1.0
	Rated output AC	11A
	Rated output DC	12V d.c. 8.3A
	Performance class	G1
	Quality class	B
	Fuel Volume (L)	15 L
	Continuous operation time (h)	10h
	Min. Fuel consumption (g/kWh)	≤360 g/kWh
	Max. temperature	40°C
	Max. altitude	1000 m
	Degree of protection against liquids	IP23M
	Size (LxWxH)	725mm x 450mm x 450mm
	Net weight	44 kg
	Measured sound pressure level, $L_{pA}$	73.96 dB(A), K =1.72 dB(A)
	Measured sound power level, $L_{wA}$	93.98 dB(A) K =1.72 dB(A)
Guaranteed sound power level	96 dB(A)	

# 13. DECLARATION OF CONFORMITY



BUILDER SAS

ZI, 32 RUE ARISTIDE BERGES – 312070 CUGNAUX – FRANCE

Declares that the machinery designated below:

LOW POWER GENERATING SET

Model: RAC3101

Serial number: 20240809927-20240810116

Complies with the provisions of the Directive “machinery” 2006/42/CE and national laws transposing it:

Also complies with the following European directives:

EMC Directive 2014/30/EU

RoHS Directive (EU) 2015/863 amending 2011/65/EU

Emission directive (EU) 2016/1628 & 2021/1398/EU

Noise directive 2000/14/CE Annex VI + 2005/88/CE

Also complies with European standards, with national standards and the following technical provisions:

EN ISO 8528-13:2016

EN 55012:2007/A1:2009

EN IEC61000-6-1:2019

Notified body of noise certificate: ISET S.r.l. Via Ca' Bella 243-Loc. Castello di Serravalle-40053  
Valsamoggia (BO)

Notified body NUMBER: 1282

Measured sound power level, LwA: 93.98 dB, K = 1.72 dB(A)

Guaranteed Sound power level: 96 dB(A)

Responsible for the technical file: Michel Krebs

Done at Cugnaux, 01/07/2024

Philippe MARIE / PDG

# 14. WARRANTY



## WARRANTY

The manufacturer guarantees the product against defects in material and workmanship for a period of 2 years from the date of the original purchase. The warranty only applies if the product is for household use. The warranty does not cover breakdowns due to normal wear and tear.

The manufacturer agrees to replace parts identified as defective by the designated distributor. The manufacturer does not accept responsibility for the replacement of the machine, in whole or in part, and/or ensuing damage.

### The warranty does not cover breakdowns due to:

- insufficient maintenance.
- abnormal assembly, adjustment or operations of the product.
- parts subject to normal wear and tear.

### The warranty does not extend to:

- shipping and packaging costs.
- using the tool for a purpose other than that for which it was designed.
- the use and maintenance of the machine done in a manner not described in the user manual.

Due to our policy of continuous product improvement, we reserve the right to alter or change specifications without notice. Consequently, the product may be different from the information contained therein, but a modification will be undertaken without notice if it is recognized as an improvement of the preceding characteristic.

### READ THE MANUAL CAREFULLY BEFORE USING THE MACHINE.

When ordering spare parts, please indicate the part number or code, you can find this in the spare parts list in this manual. Keep the purchase receipt; without it, the warranty is invalid. To help you with your product, we invite you to contact us by phone or via our website:

- **+33 (0)9.70.75.30.30**
- **<https://services.swap-europe.com/contact>**

You must create a "ticket" via the web platform.

- Register or create your account.
- Indicate the reference of the tool.
- Choose the subject of your request.
- Describe your problem.
- Attach these files: invoice or sales receipt, photo of the identification plate (serial number), photo of the part you need (for example: pins on the transformer plug which are broken).





# 15. PRODUCT FAILURE

## WHAT TO DO IF MY MACHINE BREAKS DOWN?

### **If you bought your product in a store:**

- a) Empty the fuel tank if your product has one.
- b) Make sure that your machine is complete with all accessories supplied, and clean! If this is not the case, the repairer will refuse the machine.

Go to the store with the complete machine and with the receipt or invoice.

### **If you bought your product on a website:**

- a) Empty the fuel tank if your product has one.
- b) Make sure that your machine is complete with all accessories supplied, and clean! If this is not the case, the repairer will refuse the machine.
- c) Create a SWAP-Europe service ticket on the site: <https://services.swap-europe.com> When making the request on SWAP-Europe, you must attach the invoice and the photo of the nameplate (serial number).
- d) Contact the repair station to make sure it is available before dropping off the machine.

Go to the repair station with the complete machine packed, accompanied by the purchase invoice and the station support sheet downloadable after the service request is completed on the SWAP-Europe site

For machines with engine failure from manufacturers BRIGGS & STRATTON, HONDA and RATO, please refer to the following instructions.

Repairs will be done by approved engine manufacturers of these manufacturers, see their site:

- <http://www.briggsandstratton.com/eu/fr>
- <http://www.honda-engines-eu.com/fr/service-network-page;jsessionid=5EE8456CF39CD572AA2AEEDFD290CDAE>
- <https://www.rato-europe.com/it/service-network>

**Please keep your original packaging to allow for after-sales service returns or pack your machine with a similar cardboard box of the same dimensions.**

**For any question concerning our after-sales service you can make a request on our website <https://services.swap-europe.com>**

**Our hotline remains available at +33 (9) 70 75 30 30.**



# 16. WARRANTY EXCLUSIONS

## THE WARRANTY DOES NOT COVER:

- Start-up and setting up of the product.
- Damage resulting from normal wear and tear of the product.
- Damage resulting from improper use of the product.
- Damage resulting from assembly or start-up not in accordance with the user manual.
- Breakdowns related to carburetion beyond 90 days and fouling of carburetors.
- Periodic and standard maintenance events.
- Actions of modification and dismantling that directly void the warranty.
- Products whose original authentication marking (brand, serial number) has been degraded, altered or withdrawn.
- Replacement of consumables.
- The use of non-original parts.
- Breakage of parts following impacts or projections.
- Accessories breakdowns.
- Defects and their consequences linked to any external cause.
- Loss of components and loss due to insufficient screwing.
- Cutting components and any damage related to the loosening of parts.
- Overload or overheating.
- Poor power supply quality: faulty voltage, voltage error, etc.
- Damages resulting from the deprivation of enjoyment of the product during the time necessary for repairs and more generally the costs related to the immobilization of the product.
- The costs of a second opinion established by a third party following an estimate by a SWAP-Europe repair station
- The use of a product which would show a defect or a breakage which was not the subject of an immediate report and/or repair with the services of SWAP-Europe.
- Deterioration linked to transport and storage\*.
- Launchers beyond 90 days.
- Oil, petrol, grease.
- Damages related to the use of non-compliant fuels or lubricants.

\* In accordance with transport legislation, damage related to transport must be declared to carriers within 48 hours maximum after observation by registered letter with acknowledgement of receipt.

This document is a supplement to your notice, a non-exhaustive list.

**Attention:** all orders must be checked in the presence of the delivery person. In case of refusal by the delivery person, it you must simply refuse the delivery and notify your refusal.

**Reminder:** the reserves do not exclude the notification by registered letter with acknowledgement within 72 hours.

**Information:** Thermal devices must be wintered each season (service available on the SWAP-Europe site). Batteries must be charged before being stored.



BUILDER SAS

32 rue Aristide Bergès - Z.I. du Casque - 31270 Cugnaux - France

MADE IN PRC